

# Operating Instructions



## 7" HD Waterproof Digital LCD Monitor

Please read all instructions before using the product, and keep the manual for future reference.

The product may differ from the manual description according to the upgraded.

S/W version or performance, and it may be altered without notice.

V2.0

# Contents

1. Precautions .....	1
2. Features and Specifications .....	3
3. Accessories .....	4
4. Parts Identification .....	5
5. Connections .....	6
6. Menu Operation &Functional Specification .....	7
6.1 IR Remote Control .....	7
6.2 Menu Operation .....	9
6.2.1 Desktop .....	9
6.2.2 Home Menu .....	10
6.2.3 Volume .....	11
6.2.4 Brightness .....	12
6.2.5 Mode .....	13
6.2.6 Setting .....	15
6.2.6.1 Camera .....	16
6.2.6.2 Parking Line .....	18
6.2.6.3 Language .....	20
6.2.6.4 Trigger .....	20
6.2.6.5 Auto Scan .....	23
6.2.6.6 Power On .....	24
6.2.6.7 Standard .....	25
6.2.6.8 System .....	27

# 1. Precautions

- **Storage and Keeping**

- 1) Do not expose the monitor to excessive heat or cold. The storage temperature of this device is -30~+80°C, and the operating temperature is -20~+70°C.
- 2) Avoid dropping or striking this device.
- 3) Avoid using this device in enclosed spaces, areas with excessive vibration or subject to severe impacts.
- 4) Never puncture, scratch or use abrasive cleaning materials on this device.
- 5) Do not place cables where they may be pinched or stepped on.
- 6) Leave at least a 2" space between the monitor and walls, cabinets or other objects to allow adequate air circulation around the device.

- **Operating Precautions**

- 7) The device can be powered by DC power 10V - 32V (e.g. 12V or 24V ACC).
- 8) Make sure all cables are connected properly, and check the polarity, as improper cable connections may damage the monitor. Remove the power cable connections when you do not intend to use the device.



## Warning!

1. High voltage is present within the monitor. The opening of the case should be by professionals.
2. Do not watch the video while driving unless you are monitoring the display.





## Special Notice

Occasionally, a few highlights or dark spots may occur on the LCD screen. This is a very common phenomenon in active matrix display technology, and doesn't necessarily indicate any defects or faults.

Never try to repair this device by yourself. In case of any problems, please turn off the display at once and notify our company or the authorized dealer. The monitor is a complex device, and any disassembly or modification may lead to damage and void the warranty.

● Maintenance

- 1) Remove all the cable connections from the monitor before cleaning the device.
- 2) Use a mild household detergent and clean the unit with a slightly damp, soft cloth.
- 3) Never use strong solvents such as thinner or benzene, as they might damage the finish of the device.

	Caution	
	Risk of electric shock Do not open	
<p>Caution: to reduce the risk of electric shock, Do not remove cover (or back). No user-serviceable parts inside. Refer servicing to qualified service personnel.</p>		



This symbol is intended to alert the user to the presence of uninsulated "dangerous voltage" within the product's enclosure that may be of sufficient magnitude to constitute risk of electric shock to persons.



This symbol is intended to alert the user to the presence of important operating and maintenance (servicing) instructions in the literature accompanying the appliance.



This symbol is intended to alert the user to disposing of electrical and electronic items in separate collection facilities for recovery and recycling.

**CAUTION**

You are cautioned that any changes or modifications not expressly approved in this manual could void your warranty and necessitate expensive repairs.

● Declaration of conformity

This device complies with Part 15 of the FCC Rules. Operation is subject to the following two conditions:



la FCC (Comisión Federal de Comunicaciones). El funcionamiento está sujeto a dos condiciones:

- (1) This device may not cause harmful interference.
- (2) This device must accept any interference received, including interference that may cause undesired operation.



## 2. Features and Specifications







- 1) Waterproof rating: IP66.
- 2) 7" HD quad-view monitor with LVDS interface, support input up to resolution at 1024x600.
- 3) Support 4 HD camera inputs and split-view display mode.
- 4) Multiple video formats available: 1080P30/1080P25/720P30/720P25/PAL/NTSC.
- 5) Single, dual, triplex, quad, trefoil, Y-split and PIP view display modes available.
- 6) Each channel supports independent image adjustment for horizontal-mirror, vertical-mirror view display.
- 7) Support capacitive touch screen with gestures detection; iconic menu operation.
- 8) Support remote operation.
- 9) Five trigger wires, with trigger display image, delay and priority adjustable.
- 10) Support auto scanning, with scanning sequence and hold time editable.
- 11) Adjustable parking lines available.
- 12) Support 60-level manual adjustment with high/low sensitivity selectable, and 2-level automatic adjustment of the LCD backlight.
- 13) Multiple languages available(English, French, Spanish, Netherlands, Italian, German, Russian, Portugues, Polski, Turkce , Japanese, Chinese ).
- 14) With 1.5W speaker.
- 15) Wide voltage input: 10 - 32V ; Support 12V or 24V automobile battery; with short circuit protection.
- 16) Easy installation and convenient operation, with innovative functions.
- 17) Applicable to indoor / outdoor security systems, vehicle and ship surveillance.
- 18) Compliance with CE/FCC standards.



### Special Notice

Accessory supply may vary due to different application.

### 3. Accessories

 <p>U-Support Bracket</p>	 <p>Center Mount Bracket</p>
 <p>Sun Shield</p>	 <p>IR Remote Control</p>
 <p>Angle Adjustment Screws</p>	 <p>Power Cable</p>

 **Special Notice**

Accessory supply may be different for different application.

# 4. Parts Identification

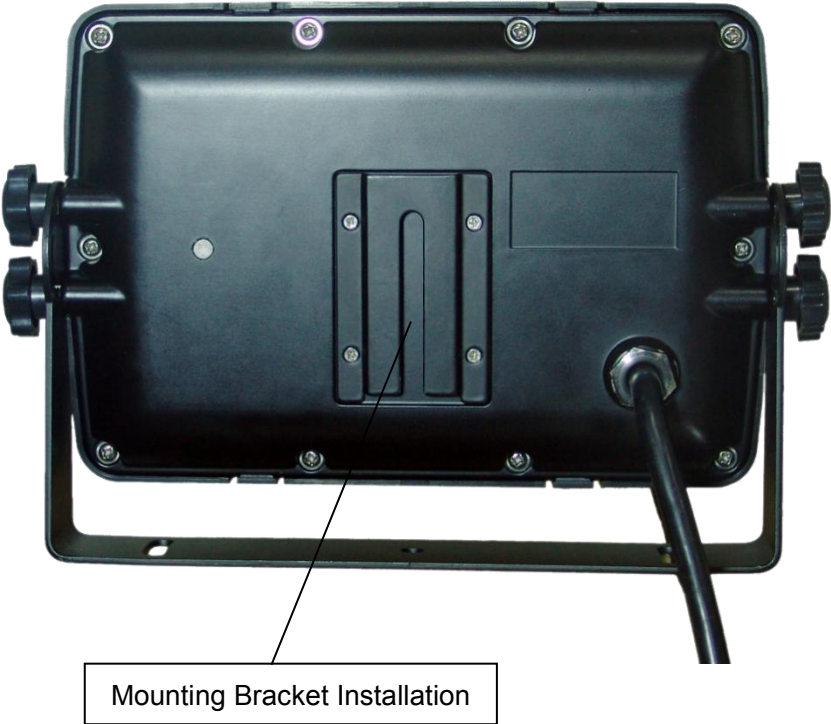
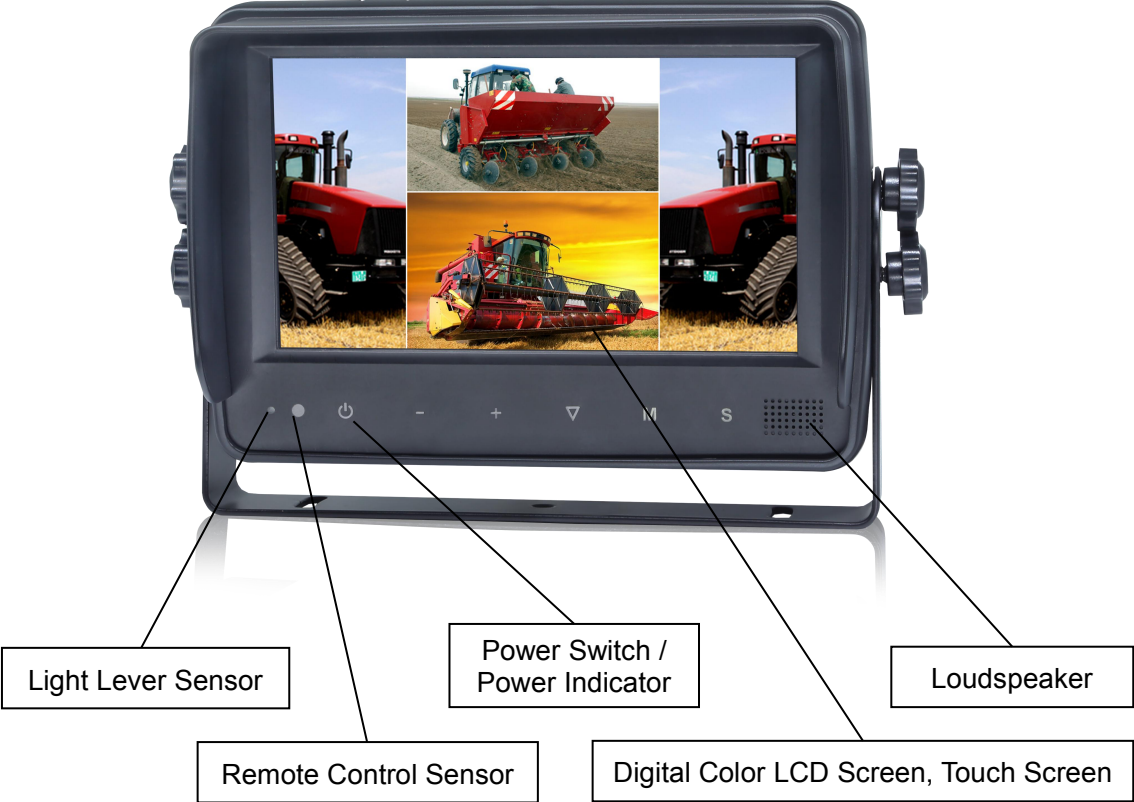

# 5. Connections

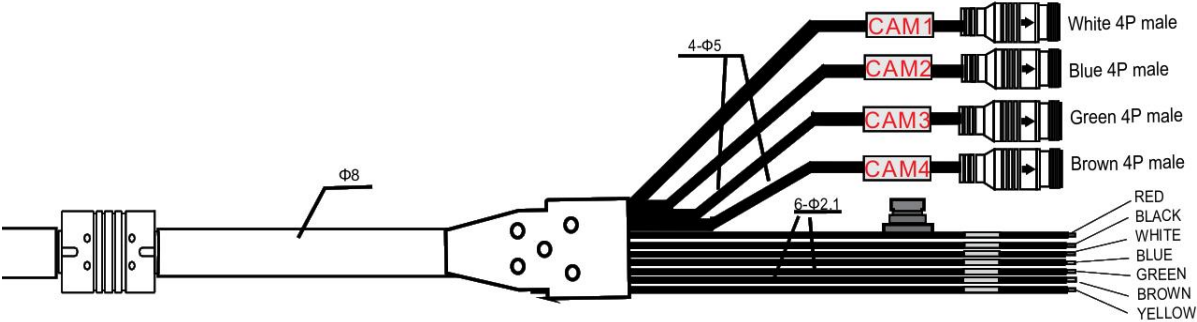

- (1) White 4P male for Camera 1.
- (2) Blue 4P male for Camera 2.
- (3) Green 4P male for Camera 3.
- (4) Brown 4P male for Camera 4.
- (5) Single red wire to power wire of DC: 10-32V.
- (6) Single black wire to GND.
- (7) Single white wire to positive power wire of Camera 1.
- (8) Single blue wire to positive power wire of Camera 2.
- (9) Single green wire to positive power wire of Camera 3.
- (10) Single brown wire to positive power wire of Camera 4.
- (11) Single yellow wire to positive power wire of Camera Split.

## 6. Menu Operation & Functional Specification

### 6.1 IR Remote Control

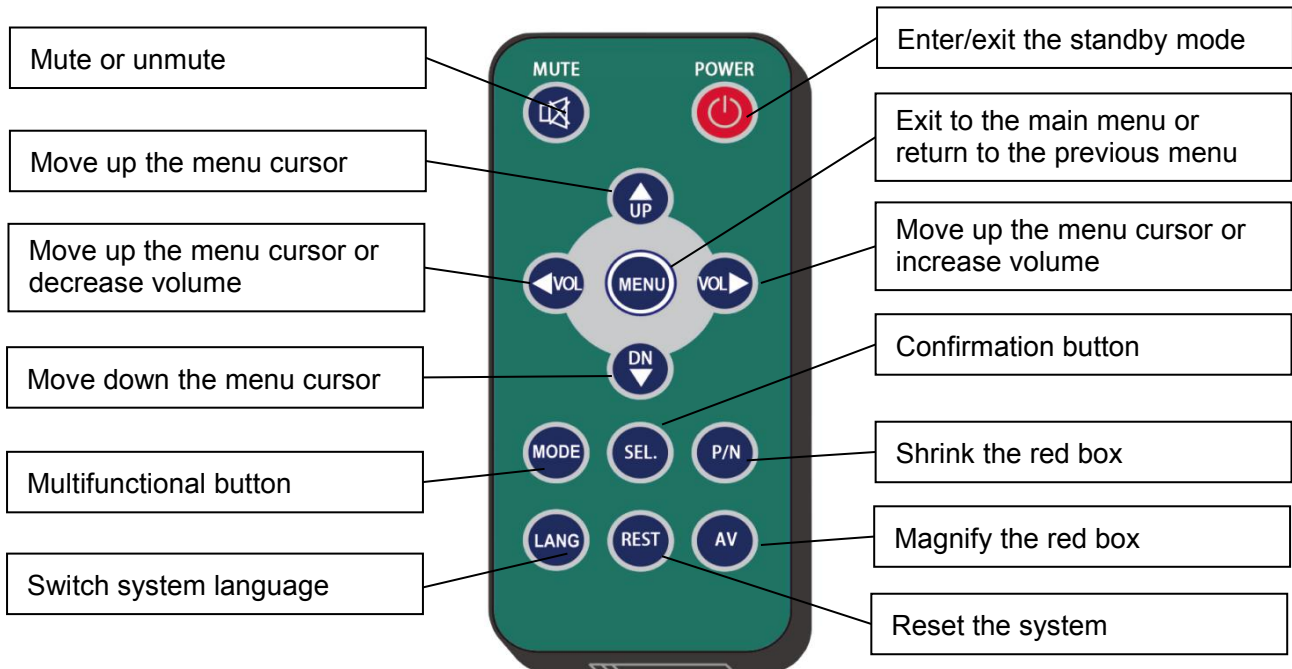

Pic.6.1

- **MUTE:**  
Mute or unmute the monitor, and open the volume adjustment menu.
- **Power:**  
Enter or exit the standby mode.
- **VOL ▷ :**  
Open the volume adjustment menu;  
Move the red box in the magnified mode;  
Move the displayed place of the magnified image;  
Move the menu cursor.
- **VOL ◁ :**  
Open the volume adjustment menu;  
Move the red box in the magnified mode;  
Move the displayed place of the magnified image;  
Move the menu cursor.

- UP:

- Switch the channel without auto scan and trigger function turned on;
  - Move the red box in the magnified mode;
  - Move the displayed place of the magnified image.

- DOWN:

- Switch the channel without special mode such as auto scan and trigger function turned on;
  - Move the red box in the magnified mode;
  - Move the displayed place of the magnified image.

- P/N:

- Shrink the red box if the red box is shown in the magnified mode.

- LANG:

- Switch to different languages on some menus.

- REST:

- Reset the system.

- AV:

- Magnify the red box if the red box is shown in the magnified mode.

- SEL:

- Enter the menu which the cursor selects;
  - Show/hide a red box to magnify the displayed area when in single view display mode and without special mode such as auto scan or trigger function turned on;
  - Magnify the image to full screen when the red box is shown in the magnified mode.

- MENU:

- Exit to the main menu or return to the previous menu;
  - Return the magnified image to normal size when the green box is shown in the magnified mode.

## 6.2 Menu Operation

### 6.2.1 Desktop

Button Panel Instructions:

- Power: Enter/exit standby mode.
- +/-: Increase/ reduce the volume.
- ▼: Switch display mode.
- M: Press for 3s to enable/disable the menu lock; short press to open home menu.

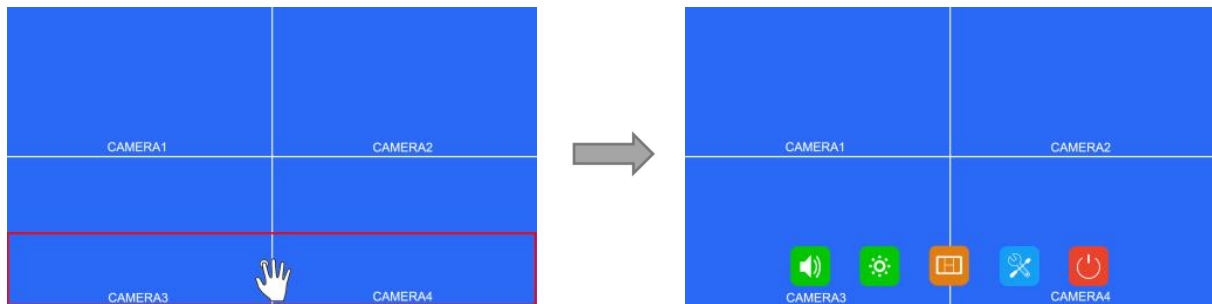

Pic. 6.2.1-1

Touch Screen Instructions:

- Click the area in the red box as the pic above to open home menu.

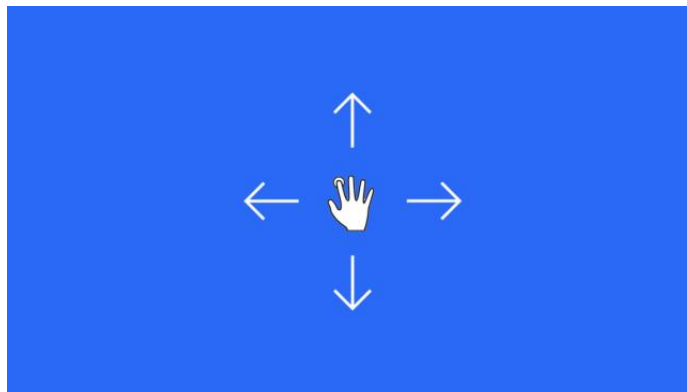

Pic. 6.2.1-2

- Without special mode such as auto scan or trigger function turned on, the swiping to the left and right of the touch screen can switch the display mode following the order:  
CAM1->CAM2->CAM3->CAM4->DUAL->TRIPLE->TREFOIL->Y-SPLIT->H.SPLIT->QUAD->PI  
P1->PIP2->PIP3->SP->CAM1.
- Support swiping up/down to exit/enter the standby mode.

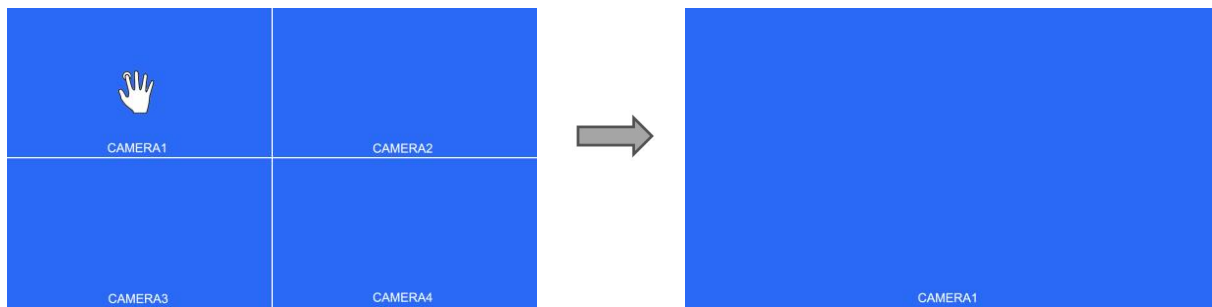

Pic. 6.2.1-3

- Without special mode such as auto scan or trigger function turned on, and when in split view display (not PIP1/2/3 or SP), single touch one of the channel to enter single view display of the channel, and touch again to enter split view.
- Without special mode such as auto scan or trigger function turned on, and when it's split view display (not PIP1/2/3 or SP), double touch different channels will pop up a green semitransparent box, and when the fingers leave the screen, the two channels will exchange the position. If the channel that you want for exchange is not displayed, you may move the touch point to the top of the screen, and the hidden channel will show up.
- Without special mode such as auto scan or trigger function turned on, and when it's split view display (not PIP1/2/3 or SP), double touch different channels will pop up a green semitransparent box, and if one of the fingers leaves the screen, when the other moves, then the green box will turn red for choosing audio output channel. If the channel that you want for audio output is not displayed, you may move the touch point to the top of the screen, and the hidden channel will show up.
- Without special mode such as auto scan or trigger function turned on, without menu, and when in single view display, double touch the screen to pop up the red box, increase or shorten the distance between the two points to enlarge/shrink the red box.

Click the area inside the red box to magnify the selected area. When entering the amplified image, the single point dragging can move the image. Single click the magnified image to go back to the normal size. Click the area outside the red box to exit the magnified mode.

## 6.2.2 Home Menu

Button Panel Instructions:

- Power: Enter/exit standby mode.
- +/-: Move the cursor.
- ▼: Enter the chosen menu.
- M: Exit home menu.

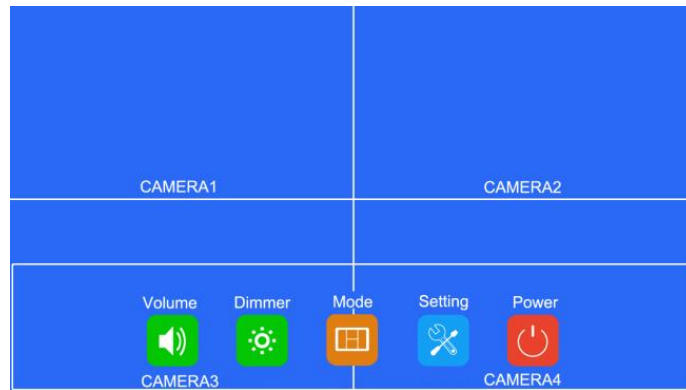

Pic.6.2.2

Touch Screen Instructions:

- Click the icon to enter the corresponding menu. Click the area outside the white box to exit home menu.

### 6.2.3 Volume

Button Panel Instructions:

- Power: Enter/exit standby mode.
- +/-: Increase/reduce the volume.
- ▼: Enter/exit the mute mode.
- M: Return to the previous menu.

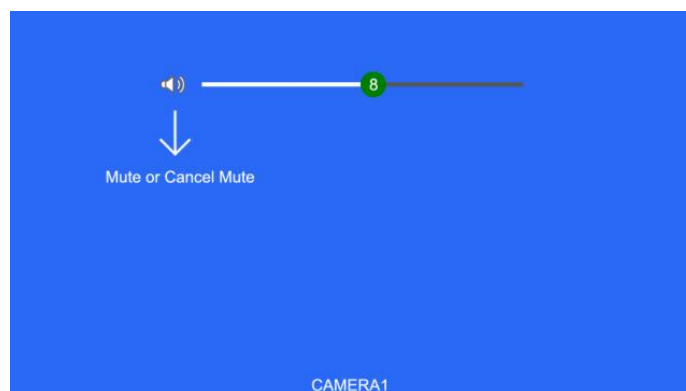

Pic.6.2.3

Touch Screen Instructions:

- Touch and drag the volume scroll bar to adjust the volume.
- Click the speaker icon to enter/exit the mute mode.

Other Instructions:

- When under mute mode, the operation of scroll bar adjustment will cancel the mute.

## 6.2.4 Brightness

### Button Panel Instructions:

- Power: Enter/exit standby mode.
- +/-: Increase/reduce the brightness.
- ▼: Switch the brightness scroll bar when the auto dim is on.
- M: Return to the previous menu.

When auto dim is off:



Pic.6.2.4-1

When auto dim is on:



Pic.6.2.4-2

### Touch Screen Instructions:

- Drag the brightness scroll bar to adjust the brightness.

### Other Instructions



: Brightness in the day.



: Brightness at night.

## 6.2.5 Mode

### Button Panel Instructions:

- Power: Enter/exit standby mode.
- +/-: Move the cursor.
- ▼: Use cursor to select the display mode. If icon  is selected, enter Split Setup menu when in split-view display mode.
- M: Return to the previous menu.

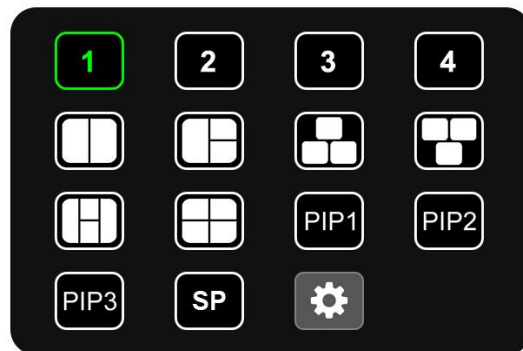

Pic.6.2.5

### Touch Instructions:

- Click the icon to switch to the corresponding display mode; if the icon  is selected, enter Split Setup menu when in split-view display mode.
- Click the area outside the menu to exit.

### 6.2.5.1 Split Setup

#### Button Panel Instructions:

- Power: Enter/exit standby mode.
- +/-: To change the corresponding features of the layer when setting up Layer 1-4; to move the cursor when setting up Audio.
- ▼: Cursor switch.
- M: Return to the previous menu.
- S: Select the camera channel and audio output channel.

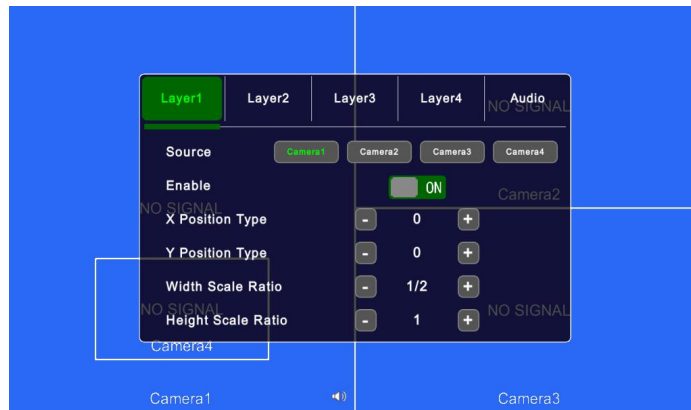

Pic.6.2.5.1

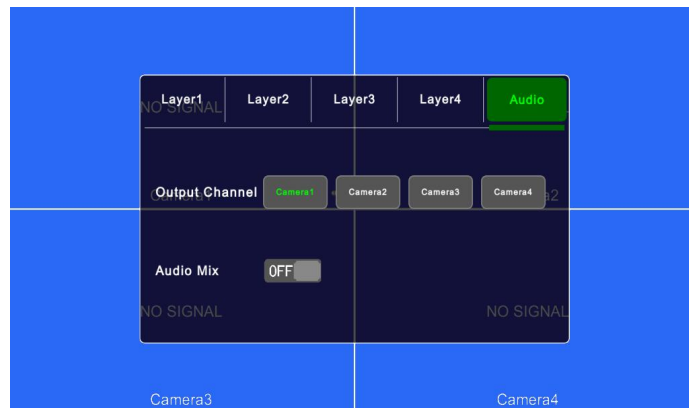

Pic.6.2.5.2

Touch Instructions:

- Click Layer 1-4/Audio icon to switch the page.
- When setting up Layer 1-4: click the combox will pop up the options list for corresponding feature, and click the option to change the feature, or long press the list and drag it to the option.
- Set Audio mix status in Audio menu setting. Turn on/off the audio mix mode and select audio output channels. Multiple audio output channels can be selected when set ON. No audio output available when none of these channels is selected.

IR Instructions:

- LANG: Switch system language.
- UP / DOWN: Same as ▼ on the button panel.
- SEL: Same as S on the button panel.

Features instructions:

- Source: The camera channel being displayed of the layer.
- Enable: If the layer is displayed.

The following features are only available when in PIP1/2/3 or SP view display mode. Specially, when in SP view display mode, the setting uses scroll bars for high precision adjustment:

- Width Scale Ratio: The horizontal down scale ratio of the layer.
- Height Scale Ratio: The vertical down scale ratio of the layer.
- X Position Type: The horizontal position of the layer.
- Y Position Type: The vertical position of the layer.
- Output Channel: Audio output channel.
- Audio Mix: Audio mix switch.

## 6.2.6 Setting

Button Panel Instructions:

- Power: Enter/exit standby mode.
- +/-: Move the cursor.
- ▼: Enter the chosen menu.
- M: Return to the previous menu.

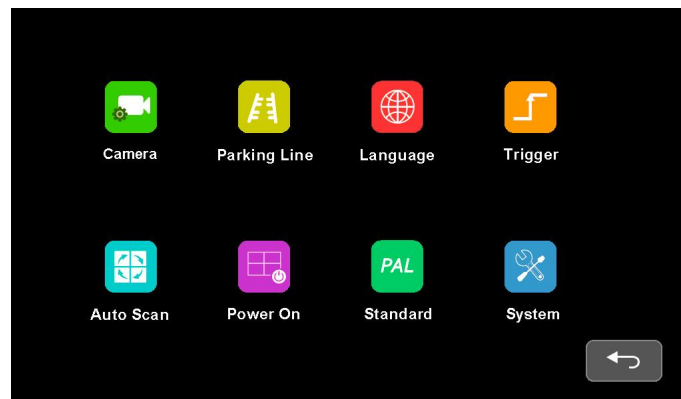

Pic.6.2.6

Touch Instructions:

- Click the icon to enter the corresponding menu.

IR Remote Instructions:

- LANG: Switch system language.

## 6.2.6.1 Camera

### Button Panel Instructions:

- Power: Enter/exit standby mode.
- +/-: Set up the features the cursor selects.
- ▼: Move the menu cursor.
- M: Return to the previous menu.



Pic.6.2.6.1

### Touch Instructions:

- Click the camera channel icons on the top to show the parameters of the corresponding channel.
- Click the ON/OFF icons or drag the scroll bars to change the features.
- Click the icon  to edit the camera channel name.

### IR Instructions:

- LANG: Switch system language.
- UP / DOWN: Same as ▼ on the button panel.

### Features Instructions:

- Camera Name: Camera channel name.
- H Mirror: Horizontal mirror.
- V Mirror: Vertical mirror.
- Automatic Power: When it's ON, the cameras will be powered only when displayed. When it's OFF, the cameras will be constantly on except in standby mode. When it's CONSTANT, the cameras will be constantly on even in standby mode.
- Audio: Volume of the camera channel. Each camera channel has its own volume setting (when under mute mode, the operation of Audio adjustment will cancel the mute).
- Brightness: Brightness of the channel.
- Contrast: Contrast of the channel.
- Color: Saturation of the channel.
- Sharpness: Sharpness of the channel.

#### 6.2.6.1.1 Keyboard (show up when editing channel name)

##### Button Panel Instructions:

- Power: Enter/exit standby mode.
- +/-: Move the cursor.
- ▼: Click the chosen icon.
- M: Go back to the Camera menu without saving.

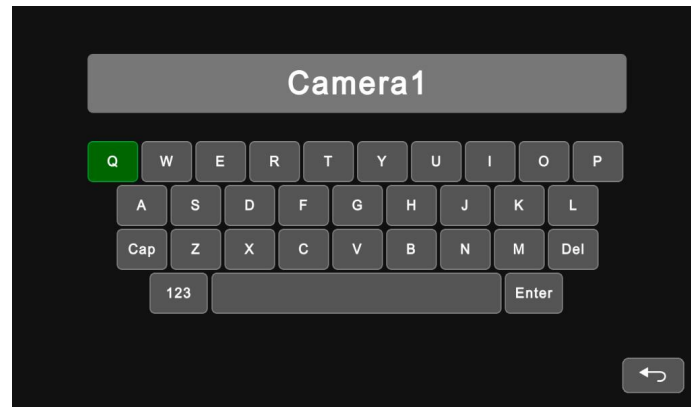

Pic.6.2.6.1.1

##### Touch Instructions:

- Click the letter icons to edit the channel name.
- Clicking the letter edit box can move the cursor and change the cursor position.

##### IR Instructions:

- MODE: Switch the keyboard mode, low-case letters->special numerical character 1->special numerical character 2->capital letters->low-case letters.
- SEL: Same as ▼ on the button panel.
- SYS: Delete one character before the cursor in the character edit box.

##### Other Instructions:

- The following keys are special for:
  - 1) Caps: Switch between capital/low-case letters.
  - 2) 123: Switch to special numerical character 1 and 2.
  - 3) Del: Delete the last letter before the edit box.
  - 4) Enter: Save the revised channel name, and go back to Camera menu.

## 6.2.6.2 Parking Line

### Button Panel Instructions:

- Power: Enter/exit standby mode.
- +/-: Move the cursor.
- ▼: Enter the chosen menu or change the state of ON/OFF/AUTO icons.
- M: Return to the previous menu.



Pic.6.2.6.2

### Touch Instructions:

- Click the ON/OFF/AUTO icons to select the display methods of parking lines: AUTO (display when triggered) / ON (constantly on) / OFF. Click the icon  to enter parking lines calibration menu "Calibrate".

### IR Instructions:

- LANG: Switch system language.

### 6.2.6.2.1 Calibrate

#### Button Panel Instructions:

- Power: Enter/exit standby mode.
- M: Return to the previous menu.
- S: Turn on/off the adjustment assistance grids.
- ▼: Short press to switch the button panel adjustment mode, and the icon representing the button panel adjustment mode on the top left will switch. Long press for 3s to switch parking line types.

#### Button Panel Adjustment Mode Instructions:



Zoom horizontally

- +/-: Horizontally magnify/ shrink the parking lines.



Zoom vertically

- +/-: Vertically magnify/ shrink the parking lines.



Move horizontally

- +/-: Parking lines move to the left/ right.



Move vertically

- +/-: Parking lines move up/down.



Zoom integrally

- +/-: Integrally magnify/ shrink the parking lines.



Parking lines reset

- +/-: Reset.

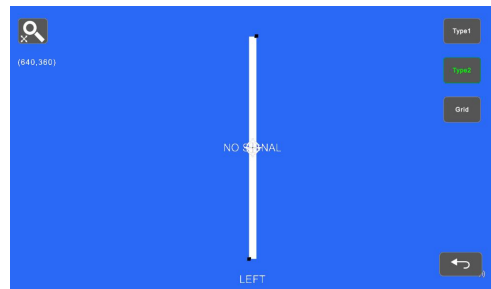
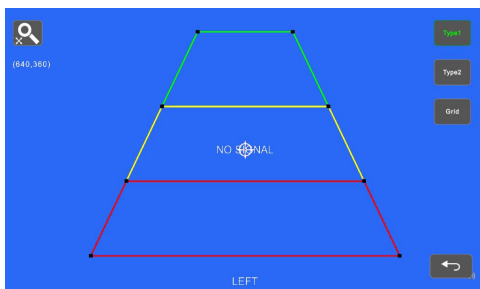

Pic.6.2.6.2.1

#### Touch Instructions:

- Drag the black vertexes of the parking line to adjust the shape. Drag the area besides the vertexes to move the whole parking line.
- Use double touch to enlarge or lessen the whole parking lines
- Tapping the icon on the top left will pop up the reset icon and tap it to resume the default config. Tap TYPE1/2 icon on the top right to switch the parking line types. Tap GRID icon to turn on/off the adjustment assistance grids.

#### IR Instructions:

- MODE: Magnify the whole parking lines.
- LANG: Shrink the whole parking lines.
- SEL: Turn on/off adjustment assistance grids.
- P/N: Switch the current focuses.
- SYS: Resume the default config.
- AV: Switch the parking line types.

#### Other Instructions:

- There will show the coordinate of the current focus on the top left.
- The icon  indicates which one the touch operation focuses on.

### 6.2.6.3 Language

Button Panel Instructions:

- Power: Enter/exit standby mode.
- +/-: Move the cursor.
- ▼: Confirm and switch system language.
- M: Return to the previous menu.

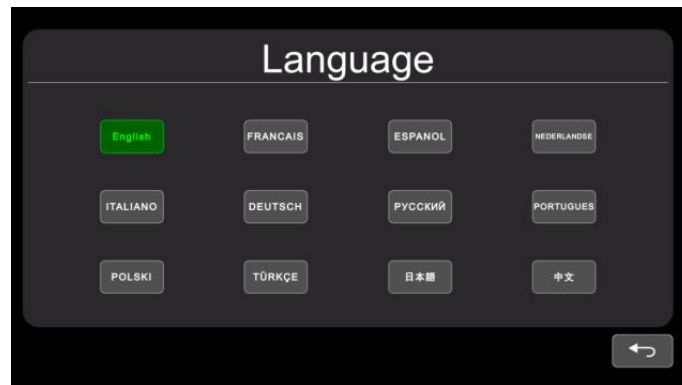

Pic.6.2.6.3

Touch Instructions

- Touch icons to switch system language.

### 6.2.6.4 Trigger

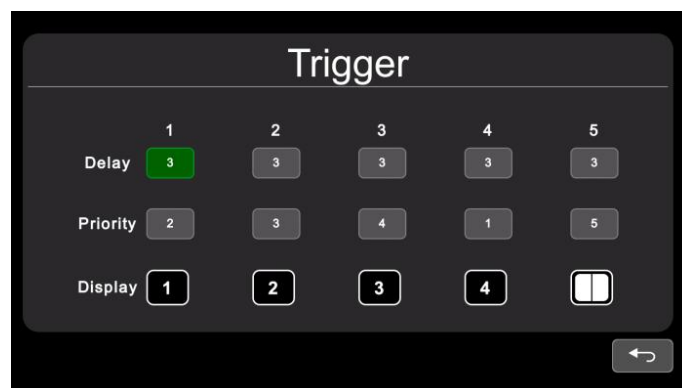

Pic.6.2.6.4

Button Panel Instructions:

- Power: Enter/exit standby mode.
- +/-: Move the cursor.
- ▼: Pop up the edit menu.
- M: Return to the previous menu.

#### Touch Instruction

- Touch any of “Delay” line to activate digital input box; Touch any of “Priority” line to activate digital selection box. Touch any of “Display” line to activate interface to select display images.

#### IR Instructions:

- LANG: Switch system language.

#### Feature Instructions:

- Delay: Trigger display image duration after trigger signal is disappeared, ranging from 0 to 60 seconds.
- Priority: Settings of trigger priorities. Trigger in higher priority can interrupt lower priority trigger. The range of the priorities is 1 to 5. The smaller the number, the higher the priority.
- Display: Settings of corresponding trigger display image.

#### Other Instructions:

- Trigger function can interrupt auto scan function.
- When the trigger signal is received, the monitor will switch into the trigger display image automatically and resume the previous state before the trigger occurs after delay time.
- Support trigger detection in standby mode.

#### 6.2.6.4.1 Input panel

##### Button Panel Instructions:

- Power: Enter/exit standby mode.
- +/-: Move the cursor.
- ▼: Select the chosen icon.
- M: Return to the previous menu without saving.

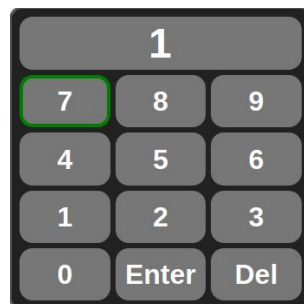

Pic.6.2.6.4.1

#### Touch Instructions:

- Touch the icons to edit the value. Settings will return back to previous menu without saving if touch beyond the panel.

#### Other Instructions:

- Input number will turn to 60 if larger than 60.
- Enter: Save input. Number input in “Delay” will be saved if return to previous menu.
- Del: Delete number.

#### 6.2.6.4.2 Priority

Button Panel Instructions:

- Power: Enter/exit standby mode.
- +/-: Move the cursor.
- M: Return to the previous menu and save.

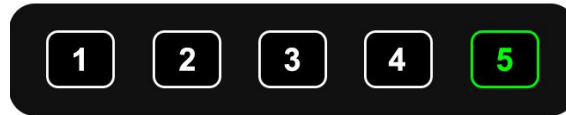

Pic.6.2.6.4.2

Touch Instructions:

- Touch number to select. Save and return previous menu by touching places out of the frame.

#### 6.2.6.4.3 Display

Button Panel Instructions:

- Power: Enter/exit standby mode.
- +/-: Move the cursor.
- ▼ / M: Return to the previous menu and save.

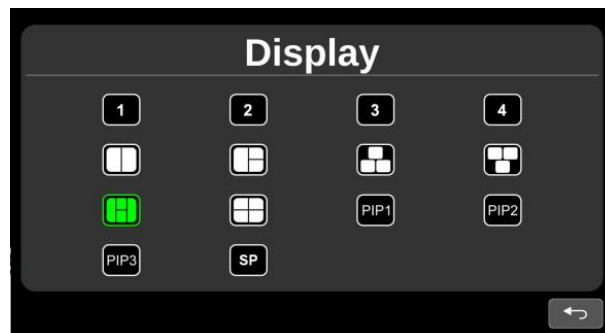

Pic.6.2.6.4.3

Touch Instructions:

- Touch to select preferred image icon and return to previous menu by touching icon .

### 6.2.6.5 Auto Scan

#### Button Panel Instructions:

- Power: Enter/exit standby mode.
- +/-: Move the cursor.
- ▼: Pop up the edit menu or change the state of ON/OFF icon.
- M: Return to the previous menu.

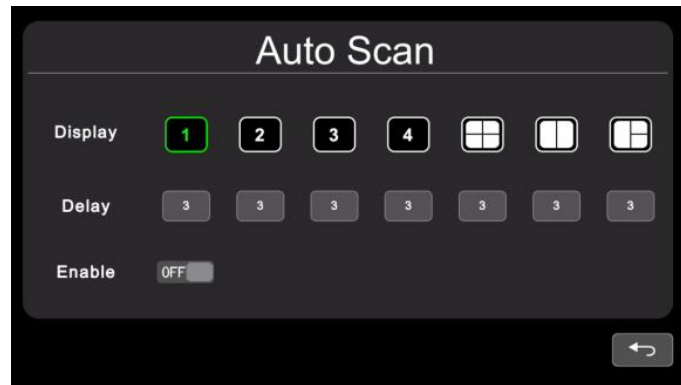

Pic.6.2.6.5

#### Touch Instructions:

- Touch any of “Delay” line to activate digital input box. Touch Enable to turn on/off auto scan function. Touch any of “Display” line to activate interface to select display images.

#### IR Instructions:

- LANG: Switch system language.

#### Feature Instructions:

- Display: to set preferred display image when in auto scanning. Details please refer to “6.2.6.4.3 Display” part.
- Delay: To set duration time of scanning image, ranging 0-60s. If delay of certain channel is set to 0, then auto scan will skip to another channel whose delay is longer than 0 second. Operation of delay is same as chapter 6.2.6.4.1 “Input panel” part.
- Enable: Turn on/off auto scan function.

#### Other Instructions:

- If parameters of “Display” or “Delay” are changed during auto scan, they will take effect on next cycle. User can also validate parameters immediately by turning off and on again the auto scan function. Auto scan can be interrupted by trigger function.

## 6.2.6.6 Power On

### Button Panel Instructions:

- Power: Enter/exit standby mode.
- +/-: Move the cursor and highlight the selected icon.
- ▼: Highlight/cancel highlight the icon selected.
- M: Return to the previous menu and save.

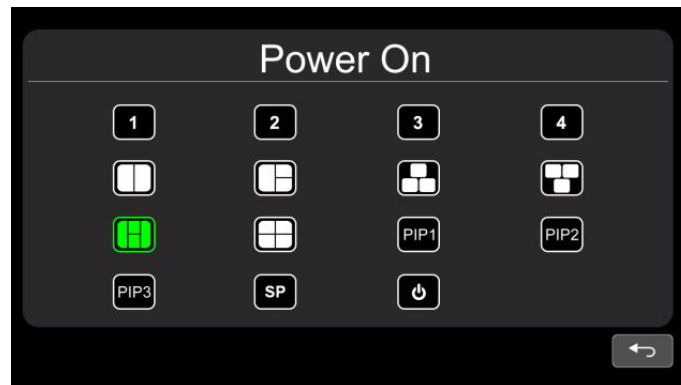

Pic.6.2.6.6

### Touch Instructions:

- If the icon is not highlighted, touch to highlight it or to cancel its highlight status.

### Other Instructions:

- Highlighted icon is corresponding display image of monitor upon start up. Last icon  once been highlighted, monitor will enter screen off standby mode directly upon power on.
- When no icon is green highlighted, it goes automatically to LAST mode, i.e. display image upon power on will be the last image of monitor when it's powered off last time.
- If the standby icon is highlighted, monitor will display start up logo if any, then go to standby mode.

### 6.2.6.7 Standard

#### Button Panel Instructions:

- Power: Enter/exit standby mode.
- +/-: Move the cursor.
- ▼: Select the chosen icon.
- M: Return to the previous menu.

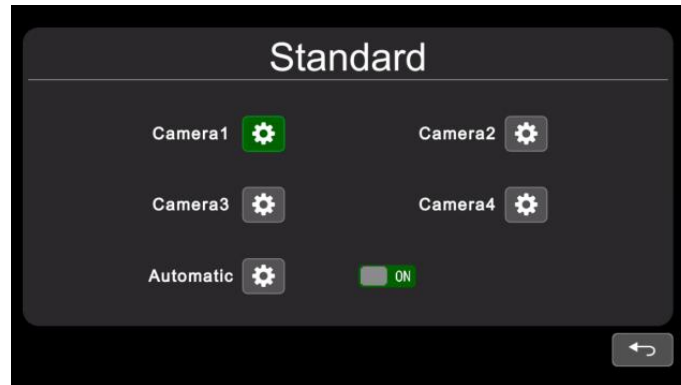

Pic.6.2.6.7-1

When automatic is on, monitor will automatically fit for input cameras. If automatic is off, the monitor will configure with user inputted settings. User is able to set input formats of corresponding cameras via touching icon  for each channel or turn on automatic to enter automatic configuration. There will be progressing of automatic configuration, and it will display information of recognized camera after 100% finished. Or the information will be empty if camera can't be recognized in automatic process.

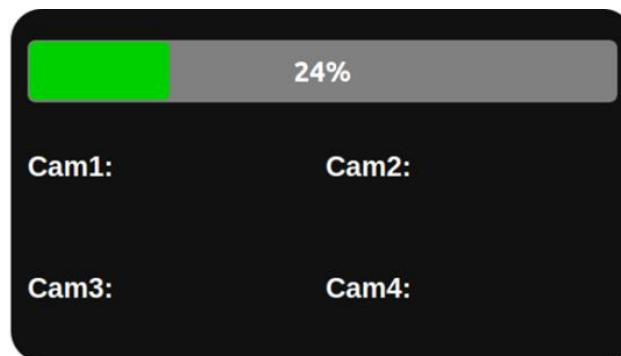

Pic.6.2.6.7-2

#### IR Instructions:

- LANG: Switch system language.
- Menu: Return to previous menu. System can exit after progress bar reaches 100% in Automatic interface.

Other Instructions:

- When “Automatic” is turned ON, HD monitor will adjust to display cameras automatically. At this time, system setting in CAMERA 1~CAMERA 4 and auto configuration of “Automatic” doesn’t work.
- When “Automatic” is turned OFF, HD monitor will respond to fixed system settings in menu of CAMERA1~CAMERA4. It allows the user to manually set each camera’s input format or auto configure by touching the icon  in “Automatic” menu.
- HD monitor won’t response to any press or touch operation before progress bar reaches to 100%. It’s able to exit by press or touch only after 100% finished.

6.2.6.7.1 Format menu

While using IR or Button Panel, the operation includes 2 selection phases.

- Phase 1<Type selection>: If PAL or NTSC is selected, system won’t enter phase 2.
- Phase 2<Resolution selection>: If user enters this interface from “Standard” menu, it enters phase 1 by default.

Button Panel Instructions:

- Power: Enter/exit standby mode.
- +/-: Move the cursor.
- ▼: Select the chosen icon. If PAL or NTSC is selected in phase 1, system won’t enter phase 2.
- M: When on phase 1, return to the previous menu. When on phase 2, return to phase 1.

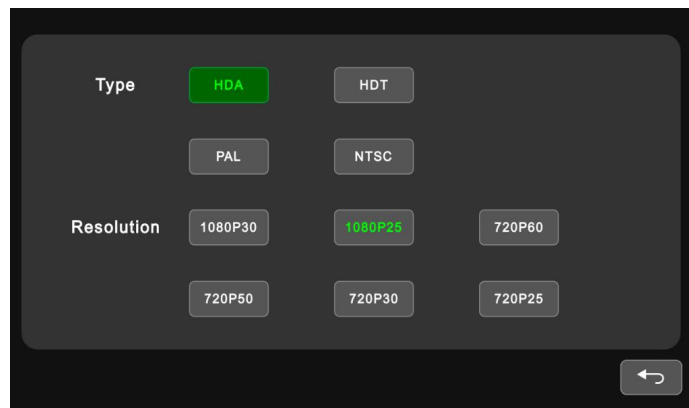

Pic.6.2.6.7.1

Touch Instructions:

- If PAL or NTSC is selected in TYPE, touch operation won’t respond on Resolution selection.

IR Instructions:

- LANG: Switch system language.

## 6.2.6.8 System

### Button Panel Instructions:

- Power: Enter/exit standby mode.
- +/-: Confirm or make settings on features.
- ▼: Move the cursor.
- M: Return to the previous menu.

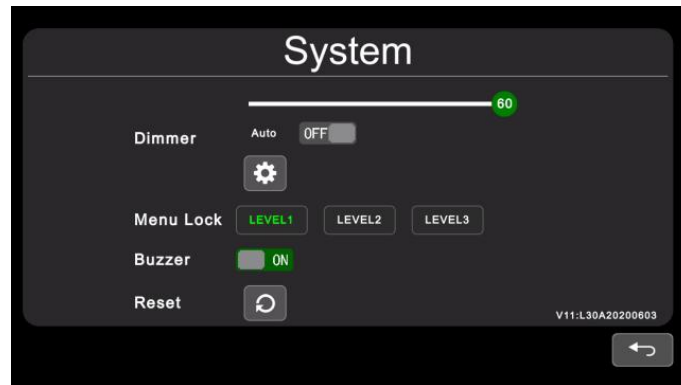

Pic.6.2.6.8

### Touch Instructions:

- Drag scroll bar of Dimmer to adjust screen backlight under day mode. When Auto of Dimmer is ON, backlight adjustment of Day/Night mode will be accessible by touching icon .

### IR Instructions:

- LANG: Switch system language.

### Feature Instructions:

- Dimmer: Scroll bar adjusts backlight under Day mode. When Auto of Dimmer is ON, monitor will turn on auto backlight function, which is, screen will turn bright in bright environments (Day mode) and turn dark in dim circumstances (Night mode). Degree and sensitivity of backlight of day or night mode can be set from menu icon .
- Menu Lock: Degree of menu lock. Continuously press M key of Button Panel or MENU button of IR remote for 3 seconds under Desktop status can enable/disable menu lock and touch operation.
  - There are 3 levels of menu lock:
    - 1) LEVEL1: All buttons fail to response. If setting of POWER ON menu is set to standby mode, system can be turned on by power button.
    - 2) LEVEL2: All buttons fail to response except for POWER, VOL+ or VOL-.
    - 3) LEVEL3: No response to M key of Button Panel and MENU button of IR remote.
- Buzzer: When it's on, it will shortly alarm if release buttons or touch.

### 6.2.6.8.1 Auto Dimmer

#### Button Panel Instructions:

- Power: Enter/exit standby mode.
- +/-: Make settings on features.
- ▼: Move the cursor.
- M: Return to the previous menu.

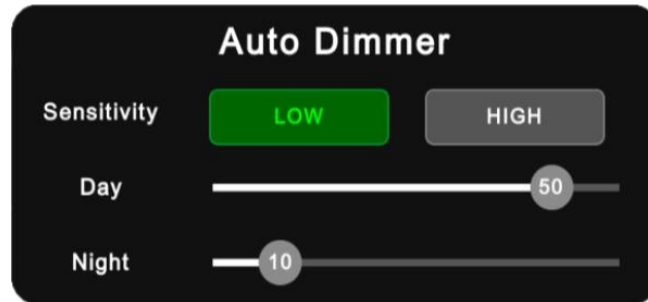

Pic.6.2.6.8.1

#### Touch Instruction:

- Drag scroll bar to adjust backlight of screen in corresponding Day/Night mode.

#### IR Instructions:

- LANG: Switch system language.

#### Feature Instructions:

- Day: Backlight degree of Day mode is always higher than that of Night mode, ranging from 0 - 60.
- Night: Backlight degree of Night mode is always lower than that of Day mode, ranging from 0 - 60.